

(1)

A small selection of electrode types

Electrodes can be produced according to drawing or sample.

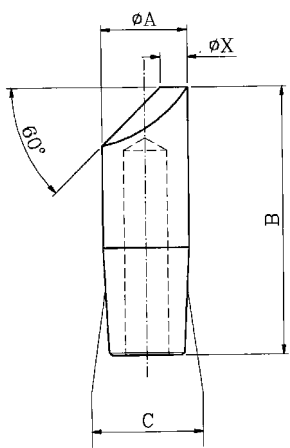

(2)

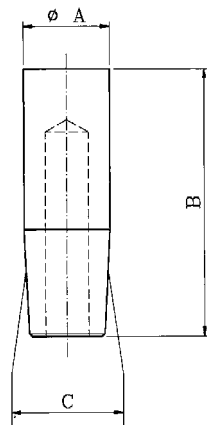

(3)

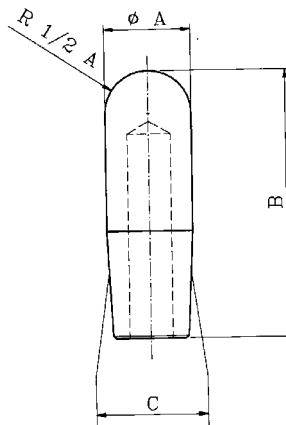

(4)

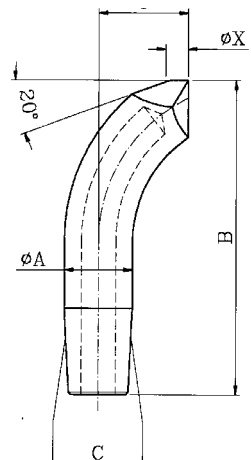

(5)

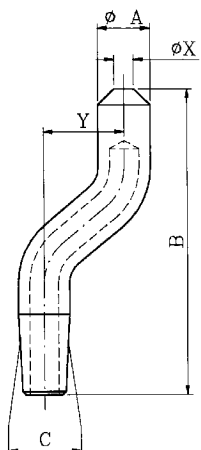

(6)

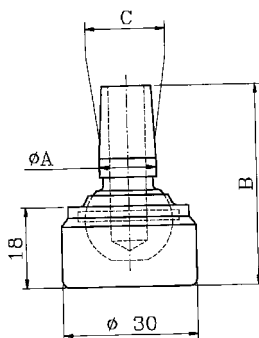

(7)

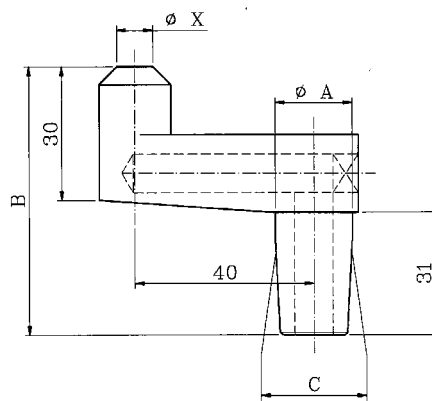

(8)

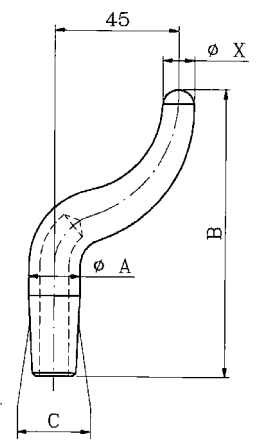

(9)